

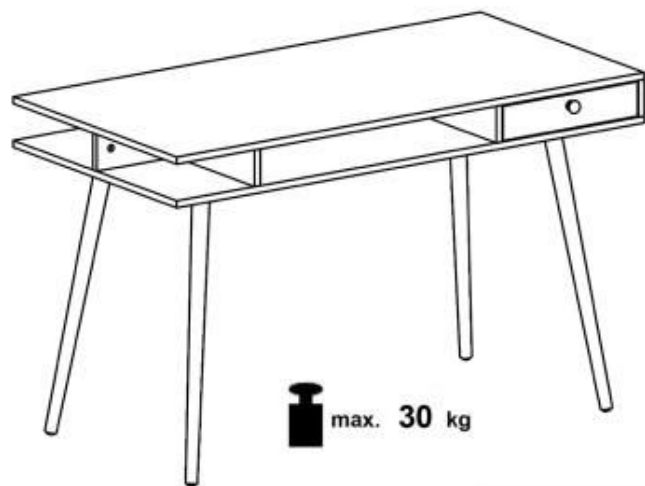





B-34 BIS

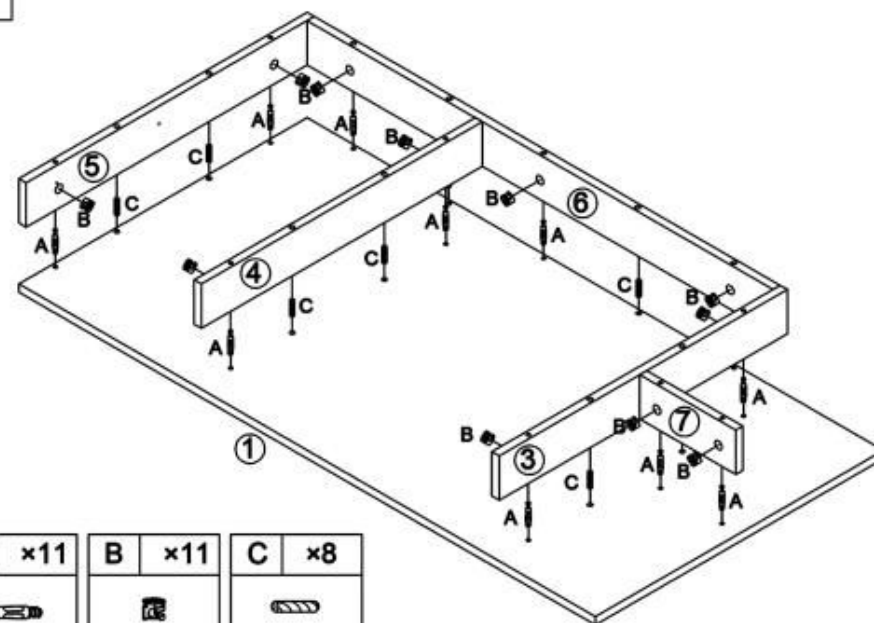

 max. 30 kg

1





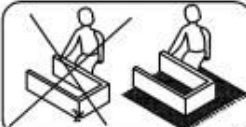
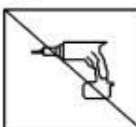



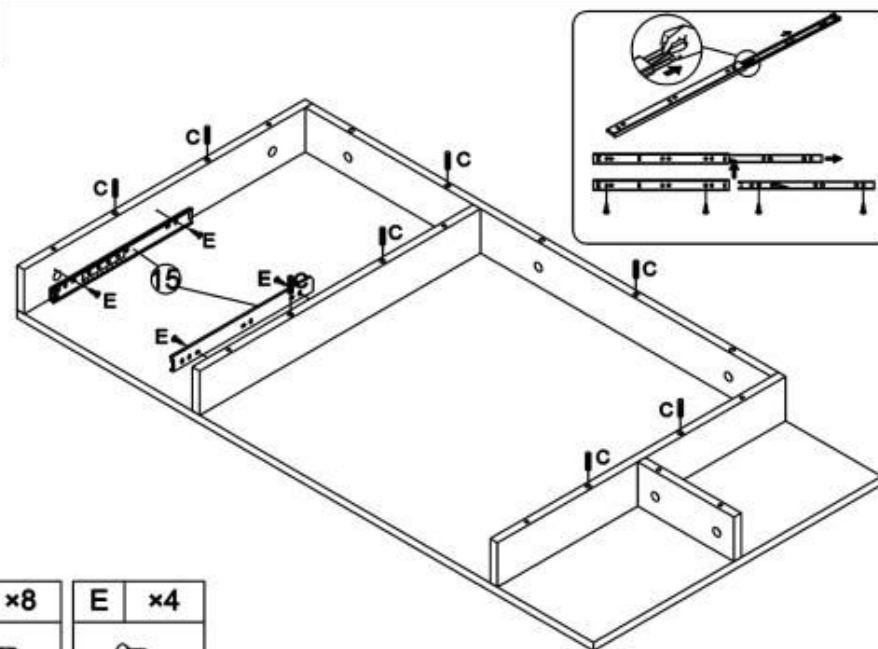





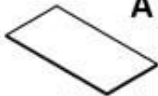









A	x11	B	x11	C	x8
					

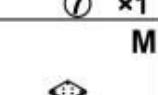
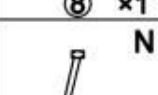
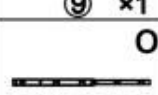

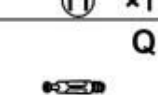
2

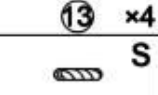

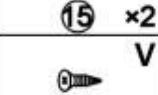
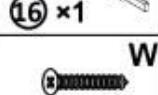
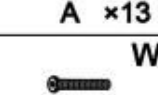
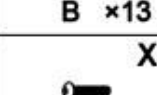
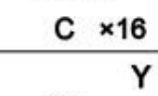
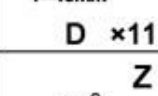
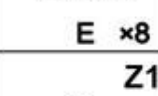
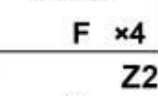
C	x8	E	x4
			

 A ① x1	 B ② x1	 C ③ x1	 D ④ x1	 E ⑤ x1	 F ⑥ x1
 G ⑦ x1	 H ⑧ x1	 I ⑨ x1	 J ⑩ x1	 K ⑪ x1	 L ⑫ x1
 M ⑬ x4	 N ⑭ x4	 O ⑮ x2	 P ⑯ x1	 Q A x13	 R B x13
 S 8x30mm C x16	 T 7x40mm D x11	 V 3.5x12mm E x8	 W 4x35mm F x4	 W 6x50mm G x2	 X 6x25mm H x16
 Y 6x15mm J x16	 Z 4x18mm K x1	 Z1 L x1	 Z2 M x4	 N x1	

HALMAR Sp. z o.o.

ul. Centralnego Okręgu Przemysłowego 2, 37-450 Stalowa Wola, POLSKA / POLAND

tel. +48 15 843 28 10, fax: +48 15 842 19 57, e-mail: office@halmar.com.pl

v.1

3

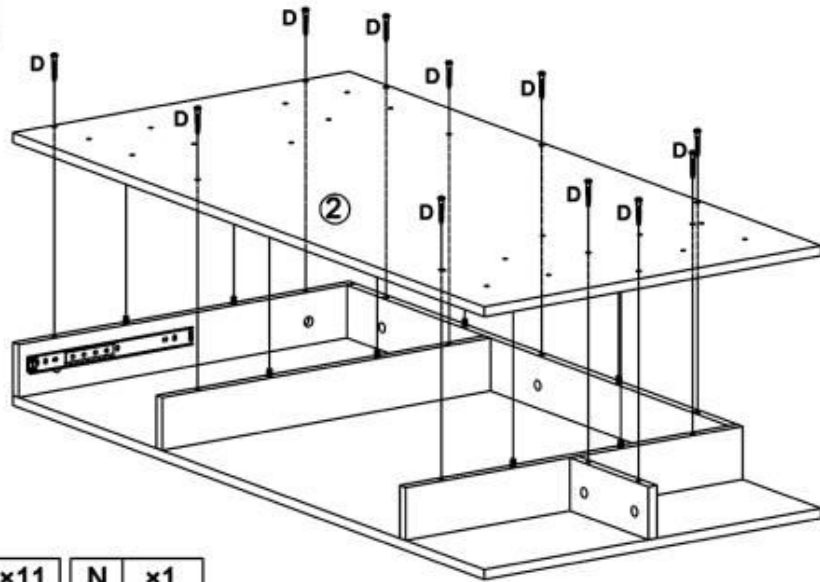

D	x11	N	x1

4

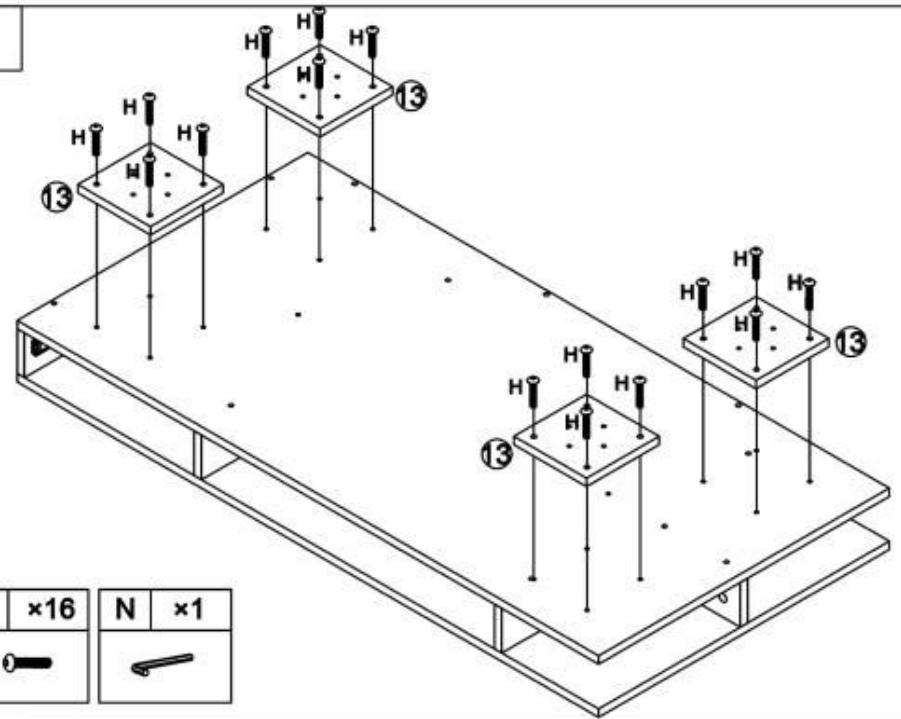

H	x16	N	x1

5

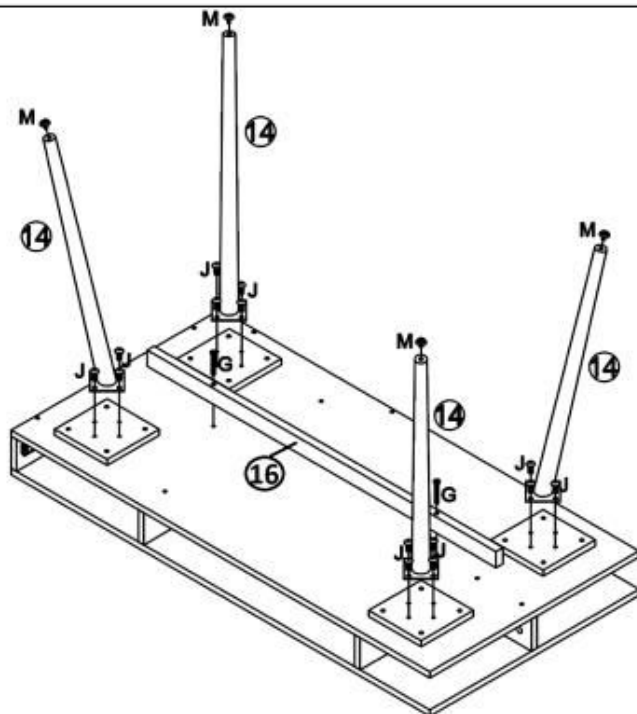

G	x2	J	x16
M	x4	N	x1

6

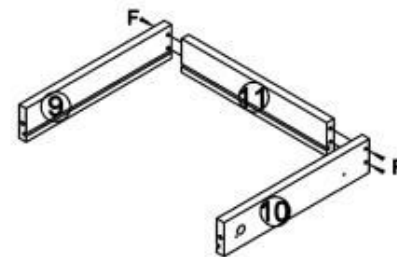

F	x4

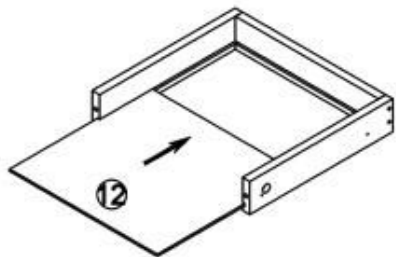
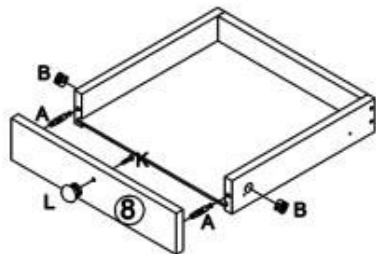
7**8**

A	x2	B	x2	K	x1	L	x1

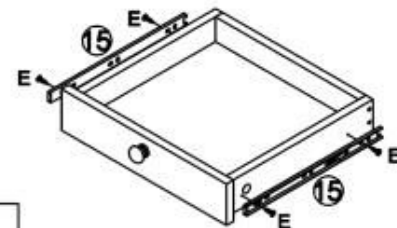
9

E	x4

10