













A		5
B		1
C		1
D		2
E		1
F		1

G		1
H	 6*30 MM for mechanism	4
I	 6*30 MM for armrests	6
J	 8*16 MM for back corner	3
K	 6mm	4
L	 6 mm	6

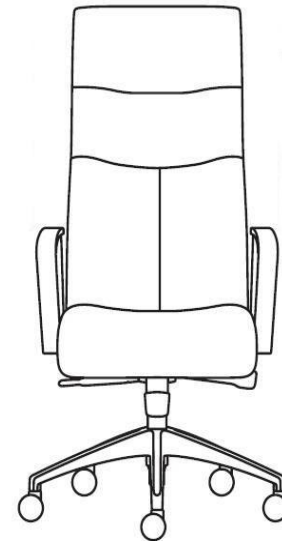
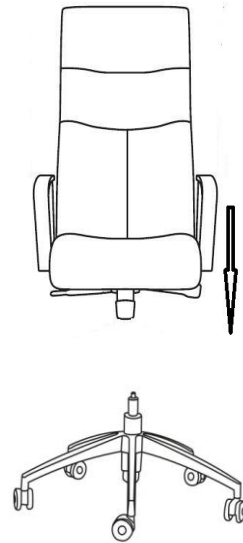
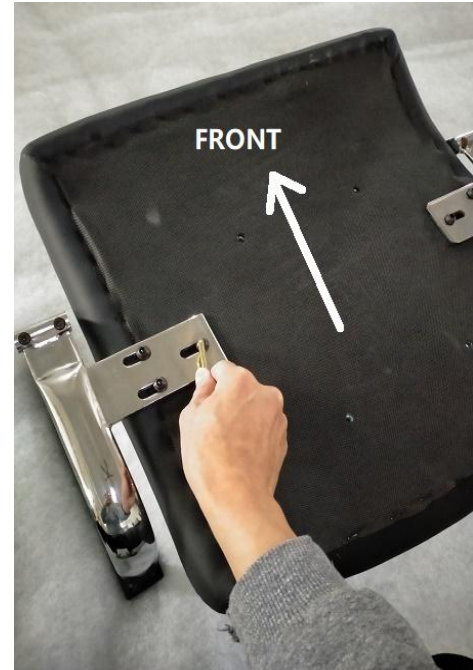
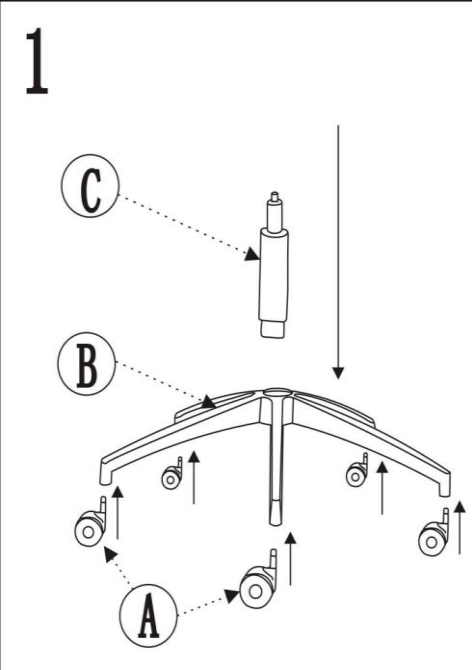

DONE